

RHINO
FROM **TOWMATE**

ACCESS PLATFORM TRAILER





INNOVATION. PRECISION. STRENGTH

Built From The Ground Up. The Rhino Access Platform Trailer.

THE ACCESS PLATFORM TRAILER

Based on our tried and tested Rhino plant trailers, the Access Platform Trailer has been specifically adapted for the transportation of scissor lifts and access platform machinery.

Working in collaboration with key players in the industry, we have developed a trailer that is as lightweight as possible, whilst still delivering on the Towmate Trailers strength and durability.

Designed to carry access platform equipment, the Rhino Access Platform Trailer comes with a specially designed pair of aluminium ramps, which are removable and stored on the side of the trailer using heavy duty fasteners whilst travelling. The trailer has grip deck rails, providing a stable base for the machine to be transported on, at the same time as removing the challenge of rotting floors by ensuring any dirt or water falls through the holes in the grip deck rather than collecting in the trailer. The trailer comes as standard with 48mm serrated propstands to support the trailer whilst loading, LED dual voltage lights and the heavy-duty running gear associated with all of our trailer ranges.



◀ SERRATED PROPSTANDS

To support the trailer whilst loading.



◀ ALUMINIUM GRIPDECK

Providing a stable base for the machine to be transported on.

ALUMINIUM RAMPS ▼

Removable and stored on the side of the trailer using heavy duty fasteners whilst travelling.



TECHNICAL SPECIFICATION

THE ACCESS PLATFORM TRAILER.

	TXAP2813-35	TXAP3117-30
CAPACITY		
Gross (KG)	3500	3000
Payload KG (standard spec)	2980	2415
Unladen Weight KG (standard spec)	520	585
DIMENSIONS		
(A) Internal Width (mm)	1300	1700
(B) Internal Length (mm)	2770	3045
(C) Overall Width (mm)	1900	5205
(D) Overall Length (mm)	4945	5205
(E) Side Height (mm)	145	145
(F) Loading Height (mm)	380	380
RUNNING GEAR		
Axles	2	2
Serrated Prop Stands	●	●
Mudguards	●	●
2.5T Rated Lashing Points 2 sets of 4	●	●
50mm Cast Steel Coupling Head	No Cost Option	No Cost Option
40mm Eye Coupling	No Cost Option	No Cost Option
LED Lights	●	●
48mm Serrated Jockey Wheel	●	●
BED & REAR LOADING		
Plywood Infill Panel	○	●
Mini Mesh Infill Panel	○	○
Aluminium Ramps	●	●
OTHER ADDITIONAL OPTIONS		
WheelSentry®	○	○

● Standard Equipment ○ Optional Equipment

DIMENSIONS

THE ACCESS PLATFORM TRAILER.

- (A) Internal Width (mm)
- (B) Internal Length (mm)
- (C) Overall Width (mm)
- (D) Overall Length (mm)
- (E) Side Height (mm)
- (F) Loading Height (mm)

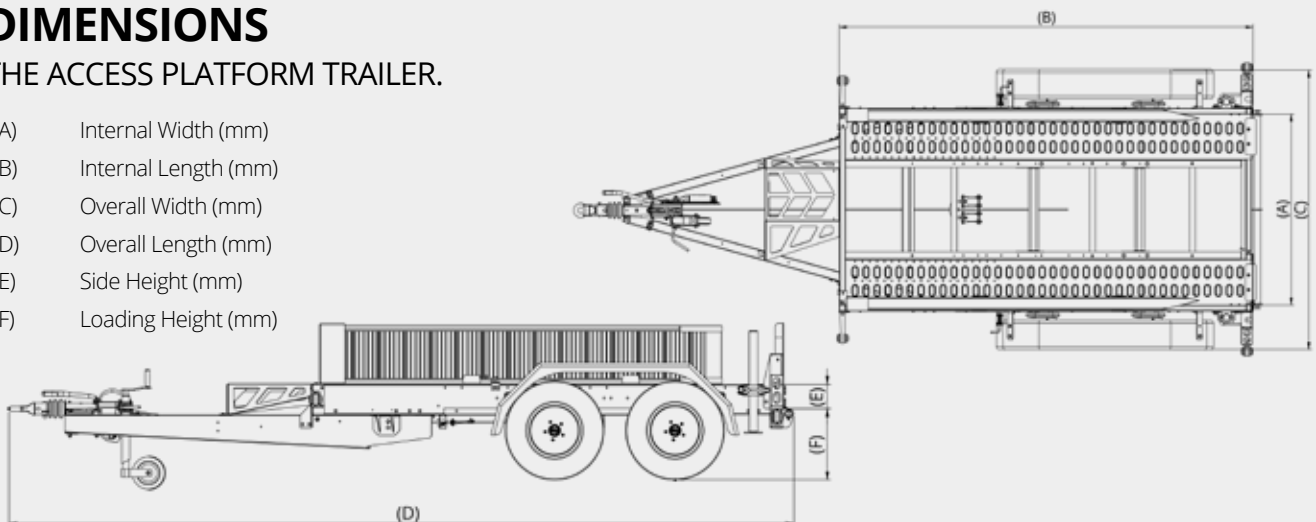

RHINO

FROM **TOWMATE**

HEAD OFFICE:

Towmate Trailers Ltd,
Whitehall Road, Colchester
Essex,
CO2 8WA

T: 01206 589550

E: sales@towmatetrailers.co.uk

www.towmatetrailers.co.uk

